

1 Safety

This instruction sheet gives details of safe installation and operation of the **Rail350** electricity meter. Labels on each meter give details of equipment ratings for safe operation. Take time to examine all labels before commencing installation. Safety symbols on the meter have specific meanings as:

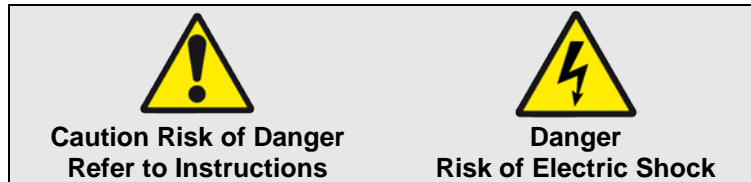

Safety may be impaired if the instructions are not followed or the meter is used in a manner not specified by the manufacturer.



Contains no user serviceable parts. Field wiring and commissioning should only be carried out by qualified personnel, in compliance with applicable national regulations.
e.g. National Electrical Code (NEC) for US; Canadian Electrical Code for Canada

For further information contact the manufacturer:

Address: Northern Design (Electronics) Ltd: 228 Bolton Road, Bradford, West Yorkshire, BD3 0QW. (UK)

Web: <http://www.ndmeter.co.uk>

2 Maintenance

The equipment should be maintained in good working order. Damaged equipment must be sent to the manufacturer (or his authorised agent) for repair. The meter may be cleaned by wiping lightly with a soft cloth. No solvents or cleaning agents should be used. All inputs and supplies must be isolated before cleaning any part of the equipment.

3 Intended Use

The **Rail350** is a precision multi function electricity monitor which measures system power parameters, including kW, Volts and Amps and displays them on an LCD. Measured parameters may be sent to remote systems for storage or display using an optional RS485 Modbus communications interface.

The **Rail350** is intended for mounting on a standard 35mm (1.38") "Top-Hat" Din Rail in a standard, secure, electrical switch enclosure so that only the front display is accessible to the end user after installation.



The safety of any system containing the meter as a component remains the responsibility of the system manufacturer. After installation in a system, the ratings of the overall system, which reflect the ratings of the meter, must be visible to the user.



*Only the front panel of the **Rail350** may remain accessible to the user after installation in a suitable switch enclosure.*



A suitably located and easily reached switch or circuit breaker must be included as part of the installation. This could, for example, be a safety-interlocking device on the door/front panel of the electrical enclosure. This switch/circuit breaker must be marked as the disconnecting device for the equipment and must comply with the relevant requirements of IEC 60947-1 and IEC 60947-3.



Disconnect / Isolate all supplies before commencing installation.

4 Standard Connections

4.1 Current Connections

4.1.1 Current Cables



Current cables must be rated for safe use in the electrical enclosure which houses the meter (e.g. UL1015) and must meet the following minimum specification: Temperature: 105°C (221°F); Insulation 600Vac.

4.1.2 Current Terminals

Voltage: 30Vac maximum
Cable: 22-14 AWG, Stripped 6.0 to 7.0mm (0.24" to 0.28")
Torque: 0.5Nm (4.4in lb)

4.2 Voltage Connections



To maintain proper insulation from the mains supply, the neutral wire should only be used in power networks where the system neutral is protectively earthed at some point.

4.2.1 Voltage Cables



Voltage cables must be rated for safe use in the electrical enclosure which houses the meter (e.g. UL1015) and must meet the following minimum specification: Temperature: 105°C (221°F); Insulation 600Vac.

4.2.2 Auxiliary Mains Supply

The meter is powered from an auxiliary mains supply which is required to energise the metering circuit and display. This can be connected in parallel with one of the measurement phase voltages if it is rated correctly.



Ensure the auxiliary mains supply L-N is powered from a correctly rated and fused AC source as specified on the meter label.

4.2.3 Voltage Terminals

Voltage: 277Vac (3-4)
480Vac (4-5, 5-6)
Cable: 30-11 AWG, Stripped 6.0 to 7.0mm (0.24" to 0.28")
Torque: 0.5Nm (4.4in lb)

4.2.4 Voltage Fuses

Fuses (US/Canada)

Rated Voltage	Type	Rupture In (A)	Standards
≥ 500Vac	Fast	1.0A	UL248 (US) C22.2 No. 248 (CAN)

Fuses (Other Countries)

Rated Voltage	Type	Rupture In (A)	Standards
≥ 500Vac	Fast	1.0A	IEC 60269 - 2

4.2.5 Auxiliary Mains Fuses

Fuses (US/Canada)

Rated Voltage	Type	Rupture In (A)	Standards
≥ 250Vac	Fast	0.1A	UL248 (US) C22.2 No. 248 (CAN)

Fuses (Other Countries)

Rated Voltage	Type	Rupture In (A)	Standards
≥ 250Vac	Fast	0.1A	IEC 60269 - 2

4.3 Communications Options

The RS485 communication port is safety isolated from the measurement voltages at a minimum of 2.21kV.



Communications cables running within an electrical enclosure may come close to high voltages and therefore must be insulated to the following minimum specification:
Safety Compliant: e.g UL1015; Operating Temperature: 105°C (221°F); Insulation 600Vac

4.3.1 RS485 Output Terminals (Optional)

Voltage: 30Vdc
Cable: 30-11 AWG, Stripped 6.0 to 7.0mm (0.24" to 0.28")
Torque: 0.5Nm (4.4in lb)

4.4 Pulse Outputs

Two isolated pulse outputs are provided for connection to external systems such as Building Energy Management Systems (BEMS), data loggers, remote counters etc. Pulse 1 is associated with the active energy (kWh) register and Pulse 2 with the reactive energy (kvarh) register. A single pulse occurs for each unit of energy on the display (eg 1 pulse per 0.1kWh). The pulse rate (amount of energy associated with each pulse) and pulse length may be set to suit the external system.

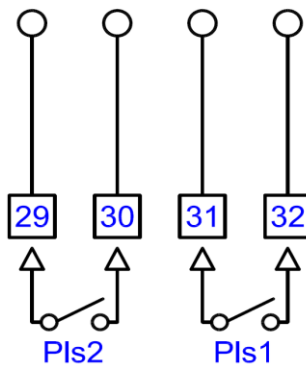

4.4.1 Pulse LEDs

Light emitting diodes (LEDs) on the front panel of the instrument remain ON during each associated output pulse.



Pulse Output Indicators



Pulse output cables running within an electrical enclosure may come close to high voltages and therefore must be insulated to the following minimum specification:
Safety Compliant: e.g UL1015; Operating Temperature: 105°C (221°F), Insulation 600Vac

4.4.2 Pulse Output Terminals

Voltage: 70Vdc/33Vac (29-30, 31-32)
Cable: 30-14 AWG, Stripped 6.0 to 7.0mm
Torque: 0.5Nm (4.4in lb)

4.5 Typical Connections

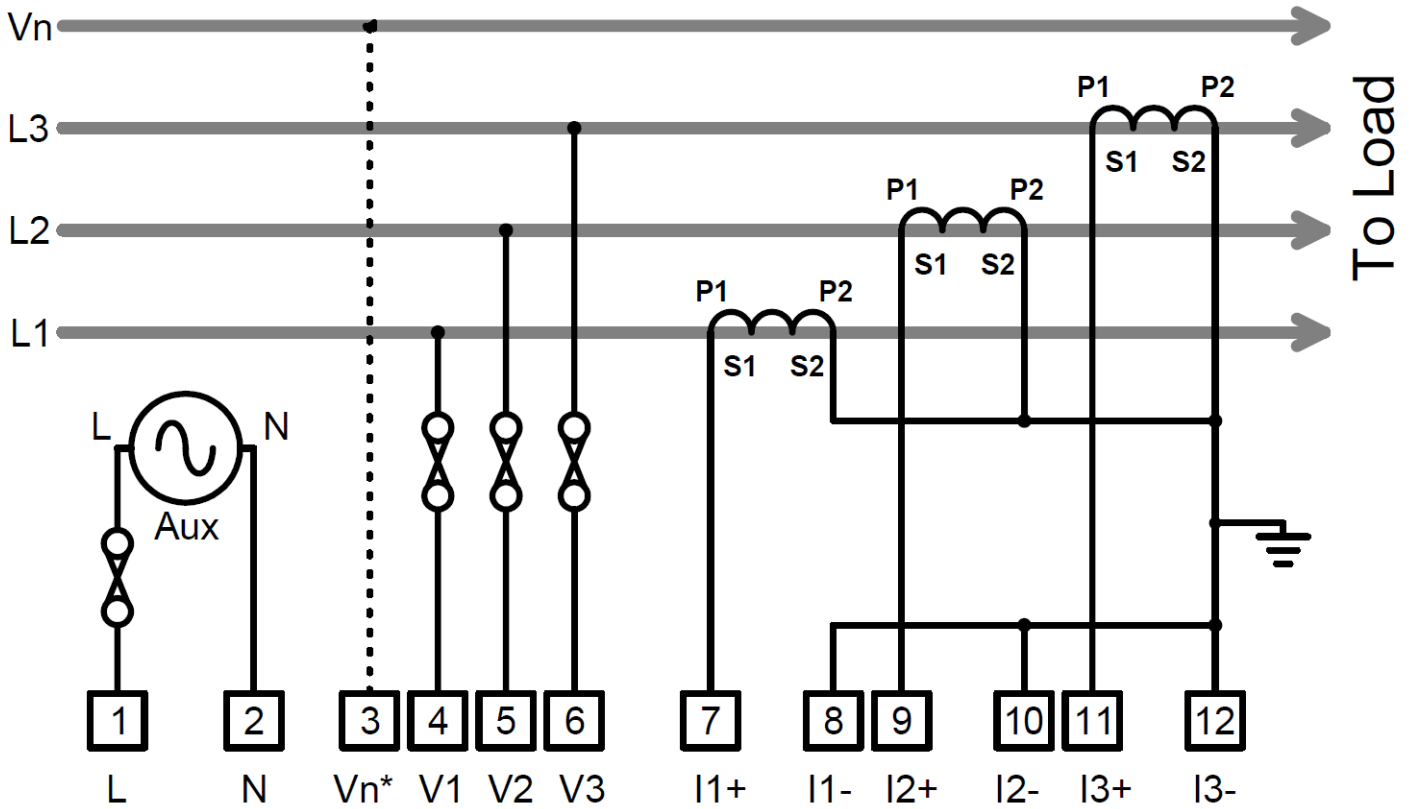

3-Phase 3 or 4-Wire (*Optional Neutral)

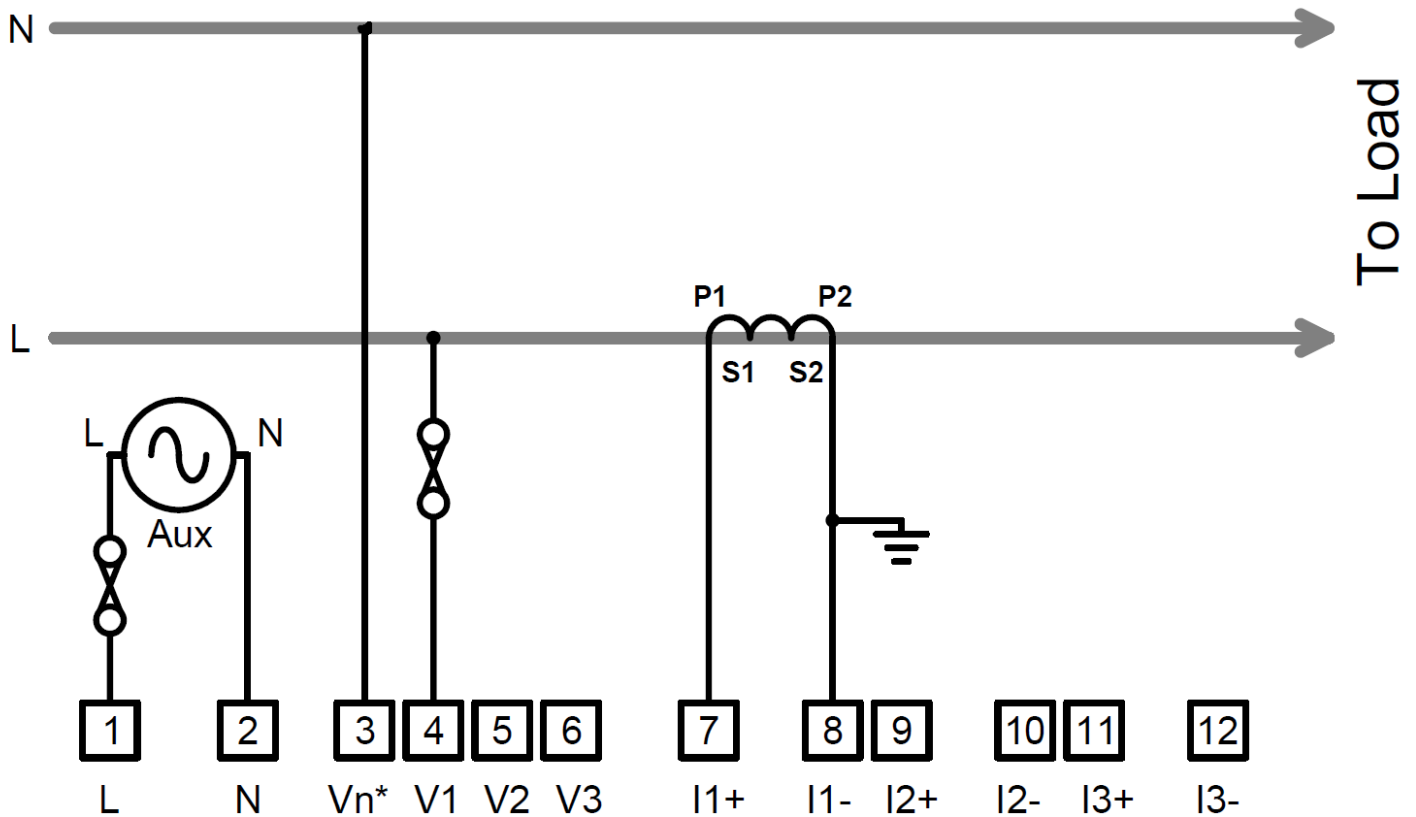

Single Phase

5 Operation

5.1 Energy Displays

Press  to select kWh kvarh and Hours Run display pages.

1234567.8 kWh

Active Energy Register



1234567.8 rh

Hours Run

1234567.8 kVArh

Reactive Energy Register^(Note 1)

The Hours Run register accumulates the total time during which the average 3-phase load current exceeds a preset level. This is always displayed with a resolution of 0.1hour. The percentage level of (I1+I2+I3) at which the Hours Run register accumulates is user programmable from 1% to 100% of full scale current.

Press  and  together and hold for 2 seconds to reset the hours run register. Scaling of the energy registers is set by the nominal input currents and voltages and remains constant during operation of the meter. Energy registers will each accumulate from zero to 99,999,999 then restart from zero.

5.2 Voltage Displays

Press  to select from the following displays;

Π1 230.0^v

Phase-n Voltages 1 - 3^(Note 1)

Λ1 400.0^v

Line-Line Voltages 1 - 3^(Note 1)

5.3 Current Displays

Press  to select from the following displays;

Π1 200.0^A

Phase 1 - 3 Current

5.4 Power Displays

Press  to select from the following displays;

144.00 kW

System Active Power

Φ 50.0

Frequency. Hz (Phase 1 voltage)

$\Pi\Phi\chi$ 1.00

System Power Factor (C=Capacitive)^(Note 1)

$\Pi 1$ 48.00 kW

Phase 1-3 Active Power^(Note 1)

$\Pi\Phi 1\chi$ 1.00

Phase 1-3 Power Factor (C=Capacitive)^(Note 1)

NOTE 1: Some display pages are removed in *Balanced Voltage Mode* (Refer to section 3.7).

6 Programming

6.1 Programming Menu

To enter programming mode:

Hold  and  together for 5 Seconds.



A **Security Code** may be required before changes to programmed parameters are allowed. This is only required if a **Security Code** greater than zero is set via serial communications. This is then stored in non-volatile memory during power interruptions.



Π1V 1234

4-Digit Security Code



To Enter A Security Code:

Press  or  to change each digit. (Lowest significant digit first).

Press  to select next most significant digit.

When a valid code is input the programming menu is displayed.

To change a Programmable Value:

Press  or  until the required value is set.

To Move to The Next Setting:

Press  until the next page in the list is displayed. Parameters are set in the following order:

Program Menu Pages



Xτ 200^A

Current Sensor Primary



YV 480^V

Nominal Line-Line V (or PT Primary)



ΠΛρ 0.1 kWh

Output Pulse Rate



ΠΛτ 0.1

Pulse On Time



Πτ0 9999

Pulse Output Test

Ηρ 20

Hours Run Trip Point (Percent Amps)

ΤρΥΕ 3Πη

Voltage Input Mode

Αυτο ροτ

CT Auto Rotation Mode

Στορινγ

Changes Are Stored to Non-Volatile Memory

After the last parameter is set the new values are stored and the meter continues to measure with the new settings.

6.2 Current Sensor Type Selection (CT)

Current sensor types are selected from a table of preferred types identified by their nominal primary current rating. The following types may be selected.

5, 50, 100, 150, 400, 800.

6.2.1 Fine Adjust

Fine Adjust Mode allows values other than those provided by the default tables to be set. To enter/exit **Fine Adjust Mode**:

Hold  and  together for 2 Seconds while setting **Ct**. **Fine Adjust Mode** is indicated by a decimal point after “Ct”.

6.3 Nominal Line-Line Voltage Selection (Un)

The nominal line-line voltage of the measured supply system may be programmed.



For systems without potential transformers (PTs) this should be the same as the nominal input of the meter as specified on the rating label (e.g. 480V).

For systems with PTs fitted this should match the nominal primary rating of the PT. The preferred values are:

11, 40, 48, 100, 110, 208, 400, 480, 600, 800, 1000, 1100, 2200, 3300, 4000, 4400,
6600, 7500, 10000, 11000, 15000, 22000, 33000, 66000, 132000, 220000, 440000

6.3.1 Fine Adjust

Fine Adjust Mode allows values other than those provided by the default tables to be set. To enter/exit **Fine Adjust Mode**:

Hold  and  together for 2 Seconds while setting **Un**. **Fine Adjust Mode** is indicated by a decimal point after “Un”.

6.4 Pulse Rate Selection Table (Counts)

Pulse values are displayed scaled as 1 count of energy.

1, 2, 5, 10, 100, 1000



6.5 Pulse On-Time Selection Table

100ms ,200ms, 500ms, 1s, 2s, 3s, 5s, 10s, 20s

6.6 Pulse Output Test

This feature allows the pulse output hardware and external system connections to be commissioned without a measured load. The LCD shows **Pto** (off) and **Ptr** (run) and the number of test pulses. The test pulse rate is set automatically dependant on the programmed pulse length (maximum 0.5Hz).

Press  to start/stop the test pulses on both outputs.

Press  and  together to stop the test pulses and simultaneously reset the test counter.

6.7 Voltage Input Mode Selection

In "**Balance Voltage Mode**" the **Rail350** may be connected to a single voltage source in place of the three phases normally required for full accuracy measurement.

When **Balanced Voltage Mode** is enabled the voltage measured on phase 1 is copied to phases 2 & 3 and all three power-factors are assumed to be unity (1.00). In this mode, the voltage connected to phase 1 on the meter may be fed from any of the 3-Phase system voltages.

This connection is valid for loads with a near unity power-factor (PF=0.95 equates to an error of 5%) and balanced 3-Phase voltages.

The combination of **Split Core Current Sensors** and **Balanced Voltage Mode** allows for rapid commissioning where access cannot be made to 3-Phase terminations. At a later date when access is possible, for example during planned maintenance, the meter may be connected safely to the 3-Phase voltages and **Balanced Voltage Mode** de-selected.

Press  or  to toggle between **Balanced Voltage Mode** and **True 3-Phase Measurement Mode**.



True 3-Phase Measurement Mode

True 3-Phase Measurement Mode



Balanced Voltage Mode

Balanced Voltage Mode

In **Balance Voltage Mode** some display menu pages are removed as they have little or no meaning and voltage is displayed as:

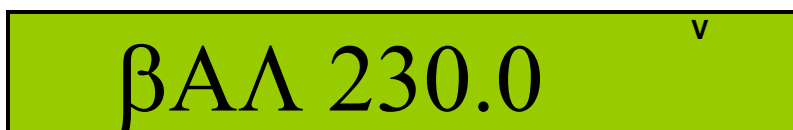

Voltage Display in Balanced Voltage Mode

Voltage Display in Balanced Voltage Mode

Single Phase kW, Power Factor and kvarh displays are removed while **Balanced Voltage Mode** is enabled.



6.8 CT Auto Rotation Mode

When “**CT Auto Rotation Mode**” is selected, the orientation of each **Current Transformer (CT)** on its respective cable becomes irrelevant. It is therefore possible to pass the cable through the centre of the CT in either direction. In this mode current direction is ignored and all power is assumed to be feeding a load (import).

When “**CT Auto Rotation Mode**” is de-selected (“**True Rotation Mode**”) current direction is monitored and measurement of import and export power is provided.

In both modes it is essential to place each CT on the correct phase conductor associated with the relevant phase voltage: Therefore link **CT1 with V1**, **CT2 with V2**, **CT3 with V3**.

Rail350 meters are normally supplied with “**CT Auto Rotation Mode**” selected. In order to detect Positive and Negative power values in all four quadrants it is necessary to de-select “**CT Auto Rotation Mode**”.

In the programming Menu Press  or  to toggle between **CT Auto Rotation Mode** and **True Rotation Mode**.



CT Auto Rotation Mode



True Rotation Mode

NOTE: **CT Auto Rotation Mode** is not available when **Balanced Voltage Mode** is selected as all Power Factors are assumed to be unity and current phase and direction is ignored.

7 Specification

INPUTS	
System	3 Phase 3 or 4 Wire Unbalanced Load or Single Phase
Voltage Un	480/277V. 3 Phase 3 or 4 Wire 400/230V; 110/63V & 208/120V optional. Others to order.
Current In	5Amp from external CTs. (1A optional) Isolated at 2.21kV
Measurement	Voltage 20% to 120% Un (Max 520V L-L, 300VL-n)
Range	Current 0.2% to 120%
Frequency Range	Fundamental 45 to 65Hz
	Harmonics Up to 30th harmonic at 50Hz Individual to the 15 th
Voltage Burden	<0.1VA per phase
Overload	Voltage x4 for 1 hour
	Current x20 for 0.5 seconds max
DISPLAY	
Type	Custom, Supertwist, LCD
Data Retention	10 years min. Stores kWh & Meter set-up
Format	8 x 6.66mm (0.31" x 0.26") high digits with DPs & 3.2mm (0.13") legends
Scaling	Direct reading. User programmable CT & VT CT Primary programmable from 5A to 25kA VT primary programmable from 11V to 440kV
Legends	Wh, kWh, MWh etc. depending on user settings
AUXILIARY SUPPLY	
Standard	230V 50/60 Hz ±15%
Options	110V 50/60 Hz ±15%
Load	5 Watt Max.
METER ACCURACY All errors ± 1 digit	
kWh	Better than Class 1 per EN 62053-21 & BS 8431
Kvarh	Better than Class 2 per EN 62053-23 & BS 8431
kW & kVA	Better than Class 0.25 IEC 60688
kvar	Better than Class 0.5 IEC 60688
Amps & Volts	Class 0.1 IEC 60688 (0.01In – 1.2In or 0.1Un – 1.2Un)
PF	±0.2° (0.05In – 1.2In and 0.2Un – 1.2Un)
Neutral Current	Class 0.5 IEC 60688 (0.05In – 1.2In)
Pulse Outputs	
Function	1 Pulse per unit of energy
Scaling	Settable between 1 & 1000 counts of kWh register
Pulse Period	0.1 sec. default; Settable between 0.1 and 20 sec
Rise & Fall Time	< 2.0ms
Type	N/O Volt free contact. Optically isolated BiFET
Contacts	100mA ac/dc max ; 70Vdc/33Vac max ; 5W maximum load
Isolation	3.5kV 50Hz 1 minute
MODBUS® Serial Comms (Option)	
Bus Type	RS485 2 wire + 0v. ½ Duplex, ¼ unit load
Protocol	MODBUS® RTU with 16 bit CRC
Baud Rate	4800, 9600 or 19,200 User settable
Address	1 – 247 User settable
Latency	Reply within 250ms max.
Command Rate	New command within 5ms of previous one
Isolation	3.5kV
GENERAL	
Temperature	Operating -10°C to +55°C (14°F to 131°F)
	Storage -25°C to +70°C (-13°F to 158°F)
Humidity	< 75% non-condensing
Environment	IP20 (when correctly mounted, as described, in a panel) Altitude <2000m (6561ft)
MECHANICAL	
Enclosure	DIN 43880, 6-Modules Wide
Material	Noryl® with fire protection to UL94-V-O. Self extinguishing
Dimensions	106 x 90 x 58mm (Cut out 106 x 45mm)
	4.17" x 3.54" x 2.28" (Cut out 4.17" x 1.77")
Weight	~ 150 gms
SAFETY	
Conforms to	EN 61010-1 Overvoltage Category III & BS 8431